



UNIVERSIDAD DE
COSTA RICA



ESCUELA DE
BIBLIOTECOLOGÍA Y
CIENCIAS DE LA
INFORMACIÓN

e-Ciencias de la Información

IoT-Based Library Automation and Monitoring system: Developing an Implementation framework of Implementation

Majid Bayani, Alberto Segura, Marjorie Alvarado and Mayra Loaiza

Technical Article 3 | Date received: 21 of July 2017 | Date corrected: 29 of November 2017 | Approval date: 05 of December 2017 | Published: 01 of January 2018

DOI: <https://doi.org/10.15517/eci.v8i1.30010>

e-Ciencias de la Información, volume 8, number 1, Jan-Jun 2017
ISSN: 1649-4142



University of Costa Rica
School of Library Science and Information Sciences
revista.ebci@ucr.ac.cr | <http://revistaebci.ucr.ac.cr>

IoT-Based Library Automation and Monitoring system: Developing an Implementation framework of Implementation

Sistema de automatización y monitoreo de bibliotecas basado en el internet de las cosas: Desarrollando un marco de implementación

Majid Bayani¹  Alberto Segura²  Marjorie Alvarado³  Mayra Loaiza⁴ 

RESUMEN

En la actualidad, las Tecnologías de Información y Comunicación (TIC) y asuntos relacionados, tales como el Internet de las Cosas (IoT, por sus siglas en inglés), tiene una influencia decisiva en todos los aspectos de la vida humana. IoT como fenómeno dominante es la transformación de la vida diaria mediante el uso de las funciones inteligentes como la de Identificación por Radio Frecuencia (RFID, por sus siglas en inglés) y las Redes de Tecnología de Sensores Inalámbricos (WSN, por sus siglas en inglés). Conforme el IoT avanza, se amplía en tamaño y dimensiones, mejorando muchos de los contextos de la sociedad; tales como, el sistema tradicional de biblioteca. Esta investigación propone un marco de ejecución sobre el empleo del IoT con el fin de renovar la estructura y esquema convencional de las bibliotecas a sistemas inteligentes en línea. El IoT permite la conectividad en tiempo real de un objeto físico (como un libro o cualquier otro tipo de texto) mediante el uso de las etiquetas RFID y sensores diminutos. El monitoreo continuo de los libros en tiempo real y la localización de objetos de manera geográfica son algunas de las características que se derivan del uso de las etiquetas de IoT. Estas características de IoT permiten la implementación de una línea de bibliotecas por medio de una cadena de suministros, la integración con diferentes tipos de tecnologías como la base de datos, la recopilación de datos y sistemas en la nube. El Internet de las Cosas también ofrece una panorámica de la vinculación entre el gran número de universidades y bibliotecas en el mundo en tiempo real, todo el tiempo. Se concluye que el implementar el IoT en sistemas de gestión de bibliotecas sería una estructura prometedora que puede jugar un papel vital en la organización de conocimientos del ser humano y en el acceso a informaciones para ayudar a investigadores, diseñadores y administradores en una manera más eficiente e inteligente.

Palabras Clave: *Internet de las Cosas, sistema de administración de bibliotecas, sistema de la nube, Tecnologías de la Información y la Comunicación (TIC).*

1 Universidad Nacional de Costa Rica (UNA), Escuela de Informática, <http://orcid.org/0000-0001-6736-0316>, Email: majid.bayani.abbasy@una.cr, COSTA RICA.

2 Universidad Nacional de Costa Rica (UNA), Escuela de Informática, Email: alberto.segura.gutierrez@una.cr, COSTA RICA.

3 Universidad Nacional de Costa Rica (UNA), Escuela de Bibliotecología, y Documentación, COSTA RICA, orcid.org/0000-0002-8384-7914, Email: marjorie.alvarado.molina@una.cr, COSTA RICA.

4 Universidad Nacional de Costa Rica (UNA), Escuela de Literatura y Ciencias del Lenguaje, <https://orcid.org/0000-0002-6208-9501>, Email: mayra.loaiza.berrocal@una.cr, COSTA RICA.



ABSTRACT

Currently, the Information and Communication Technology (ICT) and related topics such as Internet of Things (IoT) have an essential influence on all elements of human life. IoT as a prevalent phenomenon is transforming daily life by the usage of the smart features of Radio Frequency Identification (RFID) and Wireless Sensor Network (WSN) technologies. As IoT progresses, it has extended in size and dimension, improving many contexts of the society; such as, the traditional library system. This research proposes an implementation framework for employing the IoT in renovating the conventional library systems to become smart online library schemes. The IoT enables connectivity of a physical object (such as a book or other text typologies) with the real-time communication technology by using the RFID tags and tiny sensors. The continuous monitoring of books in real time and the tracking of labeled objects geographically are some desirable characteristics that result from the use of the IoT tags. These characteristics of IoT allow implementing an online library supply chain, integrating it with different types of technologies such as data bases, data gathering, and cloud systems. The Internet of Things can also provide a global linking of a huge number of libraries and universities in real time, all the time. It is concluded that the IoT-based library management systems will be a promising structure that can play a vital role in the human data organization and knowledge access by helping researchers, designers, and administrators in a more efficient and smarter manner.

Keywords: *Internet of Things (IoT), library management system, cloud system, Information and Communication Technology (ICT).*

1. INTRODUCTION

The idea of computing anywhere anytime (ubiquitous computing), was introduced in 1988 by Mark Weiser (Friedemann & Floerkemeier, 2010; Weiser, 1991). Simultaneously, the DARPA project started the implementation process of the Wireless Sensor Networks (WSNs) (Silicon Labs, 2013). A decade later, in 1999, Kevin Ashton introduced the concept of Internet of Things (IoT) to the researchers and industrial world when he was working at Labs Auto-ID centers and mentioned the term of Radio Frequency Identity Device (RFID) (Wood, 2015). RFID refers to a type of electronic-tag device that can interact with the environment. The idea behind the IoT is to use sensors, RFID tags and actuators in order to sense the events, to interact with each other, to send sensed data to a gateway for monitoring, evaluating, analyzing and making a decision about such data (Parashar, Khan, and Neha, 2016).

The IoT is a prevalent phenomenon in which the large number of smart objects can connect and plot a smart map of the devices deployed over a field. Based on the ISOC (Internet society) the IoT refers to the scenarios of the advanced connectivity of the devices, physical objects without the human intervention (ISOC, 2015). Developments of the Internet technology along with the IPv6 schemes have been enabled beyond the advanced industrial object, for example, connectivity such as machine-to-machine (M2M) communications. This extraordinary evolution was possible thanks to the progresses in information science and technologies such as cloud system, wireless communication, WSN, RDIFs that drive IoT (Höller et al., 2014; Bayani et al., 2010).

The examples of IoT applications are extended from the smart applications like intelligent homes to the complex healthcare and surgical procedure systems. The most observable IoT applications that have the potential for exponential evolution in the daily life are the smart cities, online-smart business, smart

power consumption, smart ecology and environment, security, monitoring and emergencies, transportation, industrial automation processes, educational systems, smart libraries (Bayani and Vilchez, 2017). Currently, IoT involves all human-machine-object activities and has influenced almost all aspects of the human's life.

The field of librarians also faces innovative challenges, concerns and opportunities for development in regard to the emergent technologies such as the IoT. In the close future, the Internet of Things will be overlaid with many IP-based objects that can connect physical and virtual embedded devices. As an emergent technology, IoT uses the RFID for interconnecting the unique identifiable devices within the existing configuration, creating the smart infrastructures. Although, the traditional library management systems have used the RFID barcodes in the various administrative processes, these systems are not considered as smart systems. Many systems, nowadays, need to provide connections between the virtual and physical objects to make a detailed map related to the situations and decisions, based on the obtained data. Furthermore, with the assistance of the IoT, the objects will become smart devices that can facilitate the supply administrating chain, the tracking, the monitoring, and the controls of the products in an efficient manner. A library management system should incorporate the smarter elements in its processes to cope with the efficiency limitations, converting it into an intelligent system.

This article contains a brief explanation related to the Internet of Things, and a state of art around the previous researches that is explored in the second section. Besides, the methodology of the proposed system is presented in the third segment of this study. Finally, a broad discussion and conclusions about the possible future works are presented in the fourth and fifth sections, respectively.

The main objective of this work is to propose a theoretical model design, related to the IoT-based automation library system, for providing a proper awareness to the library system designs with the purpose of incorporating the IoT's smart elements into the structure of this kind of system. Moreover, a system structure model of IoT-based library with possibility of real implementation will be presented in the third section of the article.

2. LITERATURE REVIEW

Building the smart library and its related issues; such as: monitoring, registering, establishing security, managing, tagging, tracking, self-servicing and detecting users is subject of interest and concern for the researchers. Nisha et al. (2007) designed an IoT system for library management based on the Near-field Communication (NFC) technology using the NFC embedded tags on the books, as well as the user cards. The NFC readers are used to read the tags for operation control of libraries. The users use the smart phone and a handheld reader to check the whole book information also available on a desktop.

On the other hand, Mrunal et al. (2014) introduced a RFID technology based system developing the self-service operations to improve the efficiency in the libraries. They used the RFID tags to identify the books and users to process



the information and send it to a PC that hosts a Data Base. The main goal of their design was to observe the benefits of using RFID tags and information that they could collect in the library management system and customer satisfactions. Ahmad (2016) examined the IoT usefulness in RFID technology at the Allama Iqbal Library by employing interviews and observations. He found out that the inventory control conducted by the use of RFID tags was accomplished more easily and in less time than by hand inventory. Coyle (2005) discussed the management of RFID in the libraries, and Hopkinson & Chandrakar (2006) introduced RFID at the Middlesex University learning resources.

Chang (2016) outlined an initiative development of the IoT application for libraries at the Western Michigan University. He considered that the librarians needed to observe their environments and to apply the smart IoT applications, which includes the physical smart devices such as the sensor nodes, cloud systems and controllers. The library monitoring and management are other topics that were discussed by Srinivasan and Vanithamani (2013). They designed an alert's system module related to the library book renewal, return and library dues by using the RFID and GSM mobile technology. Kumar (2016) analyzed the IoT technology in the library service and management. Butters (2008) mentioned on February 2008 that none of the Australian academic libraries used the RFID system, reason why he introduces the benefits of a RFID system for libraries and proposes several elements that could help to make clear the absence of the RFID technology's penetration into the Australian academic library area.

Chelliaha et al. (2015) focused on the consequences of the RFID implementation for three specific topics such as the people, the processes and the technology, which are related areas of the library. They analyzed a case study of the RFID application in the University of Technology Sydney (UTS) library and found out that the enabling improved the efficiency of processes for users. They also realized that the application of RFID in creative ways helped to develop an efficient supply chain management and process.

Applying WSN technology that drives IoT is discussed by Nag and Nikam (2016) with the possible usage of the IoT to improve library facilities and services stepping towards the smart library. Vaidya et al. (2017) implemented a RFID tracking PIC-microcontroller to locate accurate position of the books. Finally, Brian et al. (2014), proposed an IoT smart secure library model which defined a process to fetch the book features from its location with a Wi-Fi positioning system and NFC tags.

3.METHODOLOGY

The methodology for designing the smart library system development is based on two components; which are: the system hardware architecture and the software development.

3.1 System Architecture

The platform architecture consists of the technology that supports the IoT structure and the hardware platform.

Technologies that support IoT

The technologies used in the IoT implantation are: The Internet, IPv6, RFID, Wireless Sensor Networks (WSNs) and the cloud system. The IoT employs a set of technologies in order to provide connectivity between sensor devices (Pujara and Satyanarayanab, 2015). Connectivity is a crucial issue that will be provided by the Internet and wireless technologies. The physical objects, actuators and controllers will be connected together through the Internet connection, with a unique identification. They can also sense the events, activities or messages and pass the data to the base station point (sink). The sensed data requires being collected and stored in the private clouding servers for further analysis. The technologies that are used to perform the mentioned tasks are: The Radio Frequency Identification Device (RFID), different types of wireless communication (satellite communication, broadcast radio, Bluetooth, etc), cloud systems, and Internet protocols, such as IPv6.

These smart technologies facilitate the IoT implementation. WSNs helps establishing the non-centralized network between nodes and sending data to the gateway. RFID provides unique identification of the objects and enables to track them. Cloud servers are available in two types: Of private and public schemes to store and administrate all information.

3.2 Platform scenario

3.2.1 IoT Basic Architecture

Figure 1 illustrates a simple architecture of an IoT scenario which can be divided in three layers: Perception layer, Network layer and Application layer (Sethi and Sarangi, 2017). Based on three-layer IoT architecture, the events are sensed by the nodes and after a local processing of the data; information will be sent to a cloud system server through the gateway (base station).

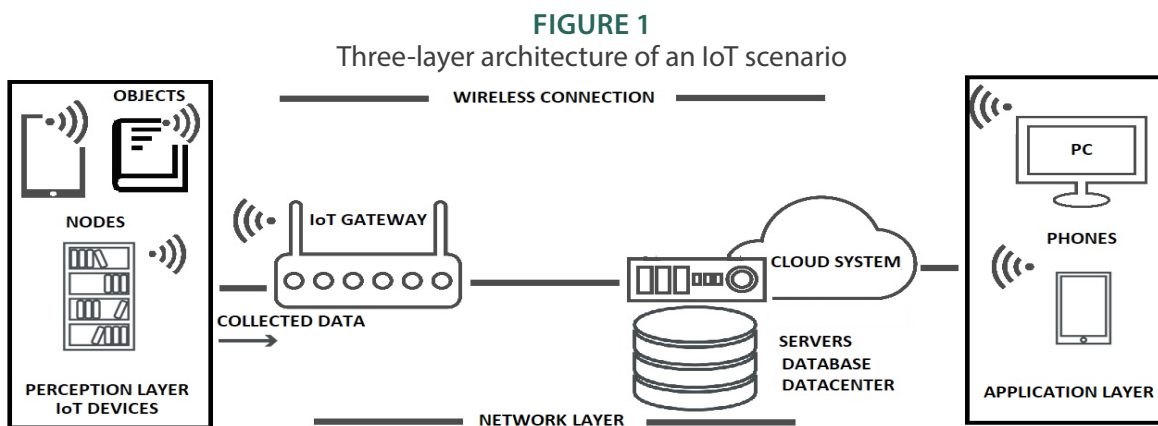

Source: Authors' elaboration

The specific function and role of each layer is described as follows:

- a. The perception layer is the physical layer; it includes the sensors (RFID, WSN etc.), the event parameters or identity existence of the object.
- b. The network layer provides connectivity between the objects, network devices, wireless or cable connections, cloud system, as well as transmitting and processing the locally obtained data. It also includes the gateway component to receive the data sensed from the perception layer.
- c. The application layer is in charge of providing applications and services to the human or non-human users (i.e. Machine to machine case). It can specify various processes, programs, and applications in which the IoT can be positioned as a smart library management system.

3.2.2 RFID Architecture

Figure 2 demonstrates a simple architecture of the RFID platform. A hand-held reader receives the signal from the RFID tag processing unit and then sends the data related to the signal to a cloud system.

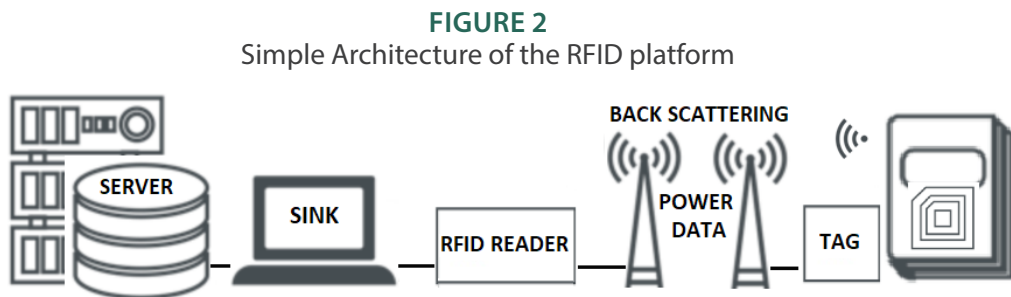

Source: Authors' elaboration

3.2.3 Wireless Sensor Networks (WSNs)

A wireless network is a computer data or voice network that uses the wireless connections between different nodes over the communication system. It is used for reducing the cost of cable installation between various nodes (Akyildiz et al., 2002).

The WSNs refer to a group of small electronic sensors (green points), that can deploy over a region (sensor field) to sense, detect the event (red point) and gather the sensory data in the base station (or sink) in order to monitor the area and make a decision related to that event. The sensor nodes in WSNs can build a non-centralized network architecture which is illustrated in Figure 3 (Bayani et al., 2010).

FIGURE 3
Basic Architecture of the Wireless Sensor Networks

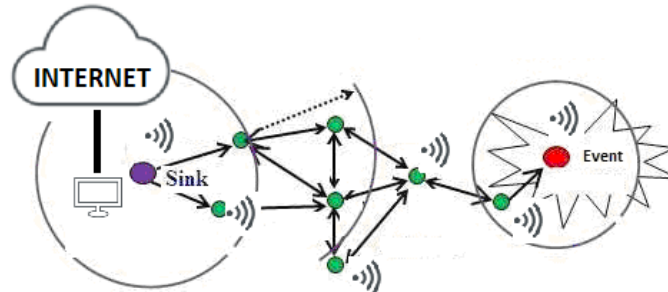

Source: Authors' elaboration

3.3 The Main IoT Library System Scenario

The main IoT library system scenario consists of some areas with their administrative divisions, which are shown in Figure 4. Technologically, the proposed scenario for IoT library system is a combination of RFID and WSN networks. The first part of the scenario is based on a RFID topology that is illustrated in Figure 5. The second part is based on the WSN network and is depicted graphically in the Figure 6.

FIGURE 4
Administrative scenario of an IoT-based Library system

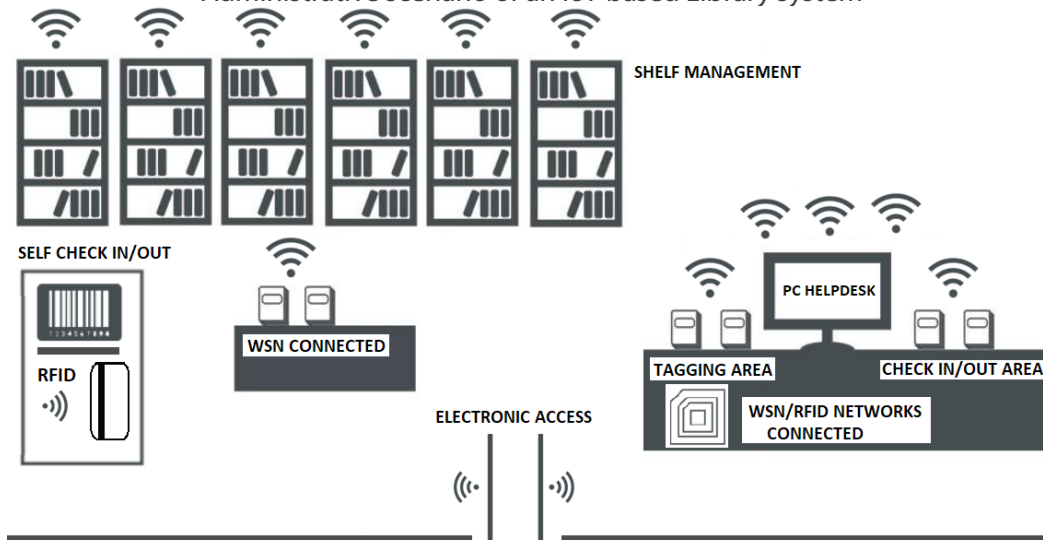

Source: Authors' elaboration

As Figure 4 demonstrates, there is a cycle of book circulation. The main administrative zone is the tagging area. The new books will be delivered to the tagging area for registering and receiving the RFID labels. The users hold the RFID ID-card and the registered book takes a unique pasted tag.

In order to identify the book-shelves a unique special tag is attached on them. When the book holders pass the electronic access gate control, a reader receives the signal of a tag passed on the book as well as the ID-card.

In this scenario, if the holder is going to enter the central, the IoT system detects the registered user and the book, and sends this information to the central cloud system to analyze and display the user in the monitoring system.

Also, it makes a previous registration of the borrowed book to its Data Base to check the waiting system. If the user is going out of the protected library environment, a detection system activates and checks if the object was registered with the checkout system to identify if the book was registered correctly or not, automatically or manually.

The process of check-in/ out could be implemented automatically. The user can scan an ID card that was registered previously. The self-checking in/ out system automatically verifies its Data Base through the servers that host the valid users.

Based on the predefined functions, if the customer was a valid user, the book could be scanned by the reader and registered on the whole system. If the book or document is getting back to the library, a message will be sent to the waiting system to let the user know about the arriving request.

All the mentioned tasks will be done through the RFID network that is part of a main IoT architecture system. The mentioned tasks are responsibility of the RFID network that is illustrated in Figure 5.

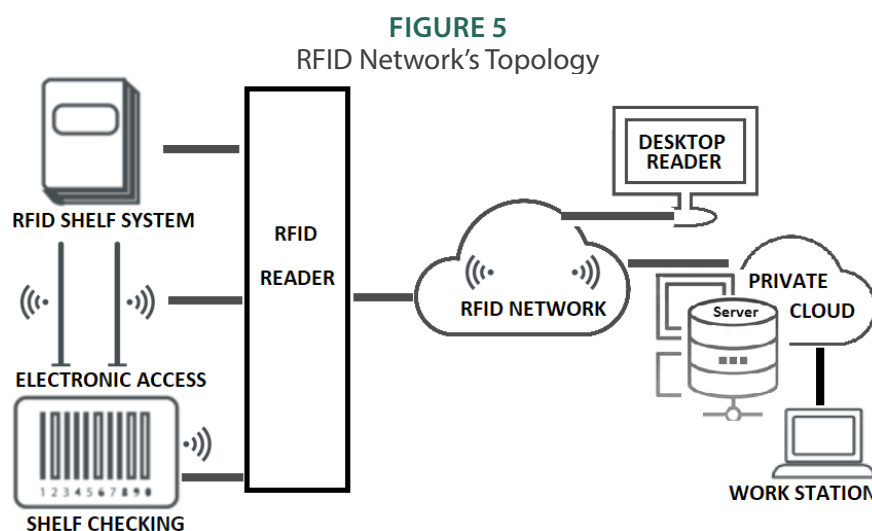

Source: Authors' elaboration

The second part of the IoT Library system is the WSN-based distribution that is shown in Figure 6. A small mote (WSN sensor) is pasted together with the RFID label on each book. A mote is a wireless node in a sensor network which is capable of sensing, gathering and local processing of the information. These sensors (motes) will not be activated in case the books are located and locked in the shelves or if they are taken out of the library. They will be active just around the library place.

A wireless connection of the nodes is built when the RFID elements are activated and scanned by RFID reader. This can occur when the books (RFID tagged) are taken to the reading area or out of the library. The monitoring system can detect geographically those elements that are not in their physical

places. This can avoid misplacing or losing the mote-labeled element such as document or books.

The WSN monitor system is enabled to physically detect the tracked objects and produces a detailed report log related to the geographical area or location of the objects. This system can be applied to books, other types of documents and the administrative staff to locate people geographically and in real time mode.

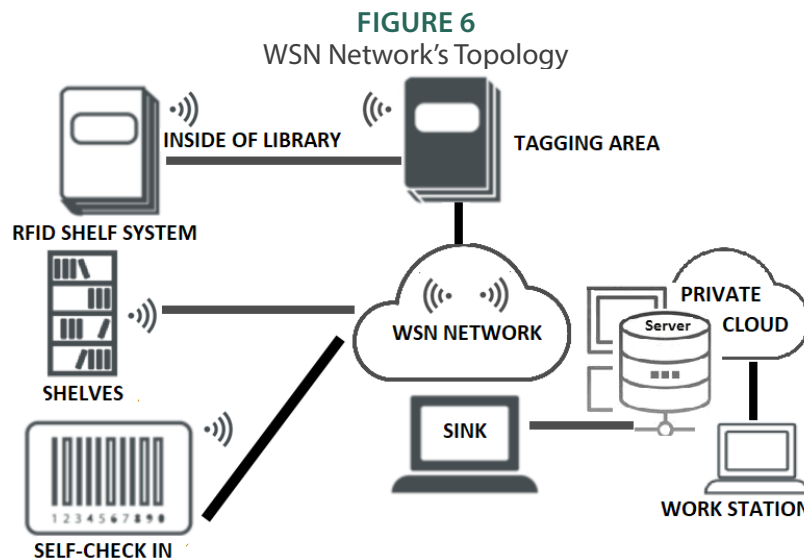

Source: Authors' elaboration

4. DISCUSSION

Most of the libraries in the world, especially those in the third world countries, are managed traditionally because of many reasons; such as, cost-benefit analysis or because there are unknown related technologies for making decisions. One of the main advantages of the IoT library management implantation is the automation of the process. The benefits for an automated system are technically likely and expected; although, sometimes politically it is not the concern of the people or administration system.

Moreover, the speed to access the information and objects (books), low energy consumption, decrease on latency, cheaper cost of maintenance and smart automated system implementations are some advantages of robotizing the processes.

Using the prevalent technology such as the Internet of Things pervades the intelligence into the structure and processes (Hamm, 2013), and consequently, makes the system more efficient. Therefore, using a technology such as IoT converts a library management structure from a traditional to a smart system that can inherit all attributes of an intelligent infrastructure, such as, linking a large number of objects.

Because there are different time zones in the world, many people are always active, and others are slept or inactive. The IoT can provide a global linking between huge number of Universities, people and research centers' libraries in real time 24/7 (Bayani & Vilchez, 2017). Building such a long connection

provides a big opportunity for researchers around the world, or inside a country (local linking), to get access to the online resources and projects.

Besides, establishing the local and global links is possible through the connection of the global network called Internet, which can facilitate the access to the unknown valuable historic and scientific resources around the world. Furthermore, the creation of a global library link among other collections, leads to build an open online global library that enables a global access to the big treasure of knowledge in the human history. Thus, a novel phenomenon called “the IoT-based world Library network” is formed. Creating this type of network before releasing the new version of IP addresses (Internet Connection Identifiers) was impossible.

The massive growth of Internet users that are using IPv4 blocks was the main concern for researchers of the Internet Engineering Task Force (IETF).

Creating another limitless scheme called IPv6 was the answer to this concern. IPv6 can support a huge number of devices enabling the Internet of Things (IoT) for assigning an IP to all connected devices or physical objects; such as: a book, document or even a refrigerator. The IoT can integrate two technologies such as RFID and WSN into a unique network by the use of the current IP version (IPv6) to manage and control the behavior of the real physical objects.

A book or a document, as an object, will have a personality. All the documents or books that have been labeled with a WSN mote sensor or RFID label after connecting to the IoT network will be alive until finishing the sensor battery. This element (book or document) has been converted to a living being.

The book tag contains an electronic chip, a small memory and a wireless radio antenna. These technical features of the attached wireless sensors enable the storing of small amounts of information related to the document and even a summary of its content in the voice format.

Another benefit that can be counted for using the IoT identifiers is the capability to physically track and locate the object.

By using the WSNs and attaching the micro-sensors on the documents, the objects create a non-centralized network that can collaborate as well as sending and resending the information related to the gateway. It permits the system to cooperate with the RFID networks, tracking down the labeled objects geographically. None of the objects or the books that carry an IoT element will be lost. Thus, continuous monitoring of the objects in a real time and online is other desirable characteristics of the using IoT tags.

Another advantage of this system is the possibility of connecting to other communication technologies and library management systems. In this type of system, an electronic waiting queue file list includes the data related to the borrowed book (not available) and the user (petitioner). Once, the borrowed book or document is detected by IoT sensor nodes and objects, a global alert system returns a comment to the inventory system, changing the status from borrowed to available.

As a result of the connections between different types of the communication technologies, the IoT alert system can send a message to the requester (messaging API) in order to get closer to the library and ask for the requested book.

The current powerful communication and wireless technology have enabled

mutual transmission between the library's IoT system and the users. The users can receive all kind of the messages coming from the library system and vice versa. The global library's IoT alert system can send a message informing about the arrival of the requested book to the users' smart-phones. The users also can remotely search the existing objects in stock and reserve them via an online reserving system. On the other hand, the system can generate an automatic informative message for closely expired orders and warn the users to return the book intime. The users can receive all these messages in their smart-phones or via electronic mails.

As previously discussed, various traditional library management systems use just one unique type of network (Tagging Network) to track the tagged books. A comparison between the architecture of these systems and the IoT-based library models, demonstrates some essential differences: The IoT-based model uses two integrated networks (RFID and WSN) for detecting, monitoring and tracking the objects, and the traditional systems are classified just as "digital systems". Besides, the IoT-based architecture incorporates the smartness feature into the system. The smartness of the proposed model makes the system, more agile for tracking the tagged articles which is an outstanding benefit of the proposed system.

However, migration from actual architecture to the smart IoT-based one means lots of modifications, adjustments and costs. The IoT technology triggers many changes in most of the active systems from the small and closed types to the flexible ones. This transition from a traditional architecture to a new and optimized structure will not be easy.

Traditional components of a library system require to be redesigned so they can support a huge number of processing events from a large volume of tagged objects by both RFID and WSN networks, and innovative IoT software and applications. Because networked devices are always on, a well-prepared maintenance team should be able to react to the incidents and system requests in real time conditions (Deichmann et al., 2015).

In order to implement the proposed system, there are some essential requirements; such as: the well-designed IoT infrastructure, IoT devices, sensors, software and applications, as well as a robust wireless connection.

In some cases, the existing infrastructure might need to be completely changed. Besides, in these situations making the IoT devices and developing compatible applications will be expensive new challenges to move forward from a traditional system to an IoT-based system. Obviously, these challenges require time and resources.

However, it is worth it, because of the large number of advantages that the IoT phenomenon offers in favor of the system agility, control, monitoring, flexibility, tractability, and performance.

5. CONCLUSIONS

At the present, the information technology and related topics such as Internet, communication technology, smart mobiles' connections and online services have a great impact on all aspects of the human being's life. The libraries are also affected directly, facing growth, advancement and challenges for development. The library atmosphere is a complicated environment in terms of the high volume of the elements, customer attending quickness, continuous growing of the objects and demands, as well as a sufficient supply chain management system. The IoT enables connectivity of a physical item like a book to the real-time communication



technology.

This characteristic of connecting all things to the Internet allows implementing an online library supply chain, integrating it with diverse types of the technologies such as wireless and Internet technology, database, data acquisition and clouding systems. Through the integration of the mentioned systems, many online services can be generated. Connecting similar IoT library systems makes possible the biggest online supply chains and services in the world, a huge number of the objects including book and users will be aware about themselves, and a very large number of the data depository research universally will be connected to each other through the Internet.

A worldwide internet-connected library system makes the global research process possible for users: Locally, by employing the RFID, WSN and cloud technologies in the IoT architecture, and by the process of identification checking of the users and books, object tracking and self-checking in/ out, which create a smart and secure library management platform. Connecting the physical objects to the Internet builds an effective structure named Web of Things (Guinard and Trifa , 2016). The Web of Things (WoT) provides an efficient interface to search and for data mining for the discovery of patterns and multiple-dimension categorizations of the books. With the use of WoT, books or documents can be classified by many attributes such as the type, author, editor, subject, location, publishing place, weight, size, volume, price, ranking, history, e-copy, updated, etc. Creating a direct link between everything and multiple physical and virtual attributes was impossible prior to the release of IoT in our real world. The WoT (by using IoT) can generate both, centralized and non-centralized networks of the books, as living objects connected to a big database. This can facilitate collecting the large volumes of data related to each element in a real-time mode.

As discussed in previous paragraphs, a large list of innovative outstanding services exists, which by using the IoT, can bring out the users a precise inventory control, theft detection, self-checking in/ out, smart segmentation and shelf, book tracking, intelligent alert system, e-copy, very low time spent in processing, smart gate, online waiting list, real time messaging service, etc. All of this means that the IoT is an advantageous technology for the future that can offer an effective customer-relationship- management (CRM) for the library systems.

Our world is saturated in the hyper-connectivity caused by the Internet and will be ready to embrace the Internet of Things very soon. Although, several IoT applications and hardware devices are being developed by some vendors, the IoT applications in the library management systems are at the early stage. The traditional RFID barcode system has its own limitation and the emergent technologies such as the IoT are trying to cope with these limitations, providing more facilities and services in an effective manner. Furthermore, the emergence of a prevalent technology, such as the Internet of Things, with lots of benefits, as it offers, has their limitations in the implementation phase at the initial point.

The first existing constraint is related to the hardware design for the special purpose of a global or local library system. It is required to create a customized design in order to adapt to the overall conditions of the library systems. Producing the huge small-size and low-cost number of WSN sensors as well as the same numbers of the RFID tags is needed in order to paste them to the library objects such as books or other kinds of documents. On the other side, the objects (books) should possess the appropriate physical conditions to take the sensors or tags.

The internal communication system is another issue that the project managers or designers will confront because of technical, administrative or financial limitations. One of the main elements in an IoT infrastructure is the storage capacity.

A private cloud system includes a server area, which is a solution for this issue; however, it is not a free or low cost option. There are two types of solutions to this issue: One is the design of the cloud area, and the second is to rent the cloud service. Both have their limitations such as the financial, technological, administrative, and location constraints. In case of leasing a cloud service, another vital issue arises, it is the security of the information, adding costs of maintenance.

There are some concerns related to the infrastructure and data security of the cloud systems. These structures are not entirely considered as the secure and risk-free systems as any other Information Technology (IT) models, applications or services. Cloud architecture provides a decentralized data and service system. Complexity of data security is increased when decentralization of information over the wireless networks and related devices are used to get services and information.

As data are being hosted in the cloud environments, the IT managers have not control over the system. To control and mitigate the security issues such as data leakage, malicious tagging and hacking attacks is a vital step forward to establish adequate security policies (Chowdhury, 2014).

Other type of preparation is needed to connect the local libraries: A well-designed telecommunication and Internet system along with a public cloud system can guarantee the interconnection between the libraries in a country or region. The employed devices in this infrastructure should be able to perceive the IoT signal and messages by using the IoT applications. As mentioned before, the applications of the IoT in many areas such as the library management system are still in progress. The IoT comprises a wide range of devices and is driving a particular segment of market in the application development. In addition to the popular operating desktop systems that are hosting the IoT interfaces, using the mobile applications is a trend.

People are spending high percentages of their time using their smart phones and mobile apps, then applying a library mobile application can increase the users' library usage rate. It is very common to use the smart phones to connect to the Internet, to buy a product, to pay a service, to watch a video and to get access to numerous online services. One of the advantages related to the library service management which the IoT can offer is that once the users download and install the library application, they can have access to all online services prepared by the system.

The IoT is considered as a complex environment, and many times the implementation of an innovative process and even the development of an application is a big challenge. As a library system provides specific services to the users, customized IoT mobile applications in the library field are facing a great deal of unavoidable challenges; such as: The IoT's hardware compatibility with the different operating systems like Android, iPhone OS (iOS) and Windows, the application's licensing costs and the speed of technology changing.



For this reason, the technical focal point of the IoT software developers is the design of the main application, which will connect to the diverse networks (RFID & WSN). An adequate investment should be done according to this essential fact.

Therefore, to cope with both, the IoT hardware and software limitations and other issues, a proper investment is required for developing the IoT library management applications and infrastructure.

In summary, it can be said that applying the IoT's technology in library management systems' implementation is promising for the upcoming future. It can play a key role in the human's global data access and knowledge propagation in a fast, more efficient and smart manner.

6. REFERENCES

- Ahmad, H. (2016). RFID Technology in Libraries: A Case Study of Allama Iqbal Library, University of Kashmir. *The Journal of Indian Library Association (JILA)*, 52(4), 109-120.
- Akyildiz, I.F., Su, W., Sankarasubramaniam, Y., Cyirci, E. (2002). Wireless Sensor Networks: A Survey. *Computer Networks*, 38(4), 393-422.
- Butters, A. (2008). RFID in Australian academic libraries: exploring the barriers to implementation. *Australian Academic & Research Libraries*, 39(3), 198-206.
- Bayani, M., Vilchez, E. (2017). Predictable Influence of IoT (Internet of Things) in the Higher Education. *International Journal of Information and Education Technology (IJJET)*, [doi:10.18178/ijjet.2017.7.12.995](https://doi.org/10.18178/ijjet.2017.7.12.995).
- Bayani, M., Marin, G., Barrantes, G. (2010). Performance Analysis of Sensor Placement Strategies on a Wireless Sensor Network. *IEEE Fourth International Conference on Sensor Technologies and Applications, Sensorcomm2010*, ISBN: 978-0-7695-4096-2, 609-617.
- Brian, A.L., Arockiam, L. and Malarchelvi, P.D. (2014). An IoT Based Secured Smart Library System with NFC Based. *International Journal of Emerging Technology in Computer Science & Electronics (IJETCSE)*, ISSN: 0976-1353, 11(5).
- Chang, A. (2016). Building an Internet of Things environment in the Library. *The VALA2016 18th Biennial Conference and Exhibition*, Melbourne Convention and Exhibition Centre, Melbourne, Australia from 9-11 February 2016.
- Chelliaha, J., Soodb, S. and Scholfieldc, S. (2015). Realising the strategic value of RFID in academic libraries: a case study of the University of Technology Sydney. *The Australian Library Journal*, 64(2)113-127.
- Chowdhury, R.R. (2014). Security in Cloud Computing. *International Journal of Computer Applications* (0975 - 8887), 96(15).
- Coyle, K. (2005). Management of RFID in libraries. *Journal of Academic Librarianship*, 31(5), 486-489.

- Deichmann, J., Roggendorf, M., Wee, D. (2015). Preparing IT systems and organizations for the Internet of Things. © 1996-2017 McKinsey & Company, URL: <https://www.mckinsey.com/industries/high-tech/our-insights/preparing-it-systems-and-organizations-for-the-internet-of-things>.
- Friedemann, M., Floerkemeier, C. (2010). From the Internet of Computers to the Internet of Things (Vom Internet der Computer zum Internet der Dinge). *Informatik- Spektrum*, Distributed Systems Group, Institute for Pervasive Computing, ETH Zurich. ©Springer-Verlag Berlin Heidelberg ,33(2),107-121.
- Guinard, D., Trifa, V. (2016). Building the Web of Things: With examples in Node.js and Raspberry Pi. Publisher: Manning Publications; 1 edition (June 18, 2016), ISBN-10: 1617292680, 344p.
- Hopkinson, A., Chandrakar, R. (2006). Introducing RFID at Middlesex University learning resources. Program, electronic library and information systems, ISSN: 0033-0337, 46(1), 89-97.
- Hamm, S., Kelly III, J. (2013) .Smart Machines: IBM's Watson and the Era of Cognitive Computing. Publisher: Columbia University Press ISBN-10: 023116856X ISBN-13: 978-0231168564, Series: Columbia Business School Publishing.
- Höller, J., Tsiatsis, V., Mulligan, C., Karnouskos, S., Avesand, S. and Boyle, D. (2014). From Machine-to-Machine to the Internet of Things: Introduction to a New Age of Intelligence. Elsevier, ISBN 978-0-12-407684-6, eBook ISBN: 9780080994017, 352pp.
- ISOC. (2015). The Internet of Things: An Overview: Understanding the Issues and Challenges of a More Connected World. URL: https://www.internetsociety.org/sites/default/files/ISOC-IoT-Overview-20151014_0.pdf.
- Kumar, S. (2016). Application of 'Internet of Things' (IoT) Technology in Library Management & Service. *International Journal of Scientific & Innovative Research Studies (IJSIRS)*,4(2).
- Mrunal, A., Jadhav, I., Pachpande, S.R., Rane, P. (2014), A Paper on RFID in Library Automation .*International Journal of Advanced Electronics & Communication systems*, Proceeding of International Conference on Modeling and Simulation in Engineering & Technology (ICMSET-2014).
- Nag, A. , Nikam, K. (2016). Internet of Things Applications in Academic Libraries. *International Journal of Information Technology and Library Science*, ISSN 2349-235X, 5(1), 1-7.
- Nisha, P., Karande, P., Desai, J., Pereira, S. (2017). Internet of Things for library Management System. *International Journal of Engineering Science & Computing (IJESC)* ,7(4), 10021-10024.
- Parashar, R., Khan, A., and Neha. (2016). A Survey: The Internet of Things. *International Journal of Technical Research and Applications*, e-ISSN: 2320-8163, 3 (4), 251-257.
- Pujara, S.M., Satyanarayanab, K.V. (2015). Internet of Things and libraries. *Annals of Library and Information Studies*, 62(3), 186-190.



Sethi, P., Sarangi, S.R. (2017). Internet of Things: Architectures, Protocols, and Applications. *Journal of Electrical and Computer Engineering* .Vol. 2017 , Article ID 9324035, 25 pages.

Silicon Labs, (2013). The evolution of wireless sensor networks. URL: <http://www.silabs.com/Support%20Documents/TechnicalDocs/evolution-of-wireless-sensor-networks.pdf>.

Srinivasan, S., Vanithamani, R. (2013). An Internet of things Approach to Library Management and Monitoring. *International Journal of Research in Engineering & Advanced Technology (IJREAT)*, ISSN: 2320-8791, 1(2).

Vaidya, O., Snehal Kulthe, S., Khaire, A. and Kela, N. (2017). Design & Implementation of RFID based book tracking system in library. *International Journal of Electrical and Electronics Engineers (IJEET)*, 9(1).

Weiser, M. (1991). The Computer for the 21st Century. Palo Alto Research Center (PARC), *Scientific American Ubicomp*, Bitcode: 1991 SciAm, 265(3), 94–104.

Wood, A. (2015). The Internet of things is revolutionizing our lives, but standards are a must .Retrieved from <https://www.theguardian.com/media-network/2015/mar/31/the-internet-of-things-is-revolutionising-our-lives-but-standards-are-a-must> ,*Theguardian.com*.



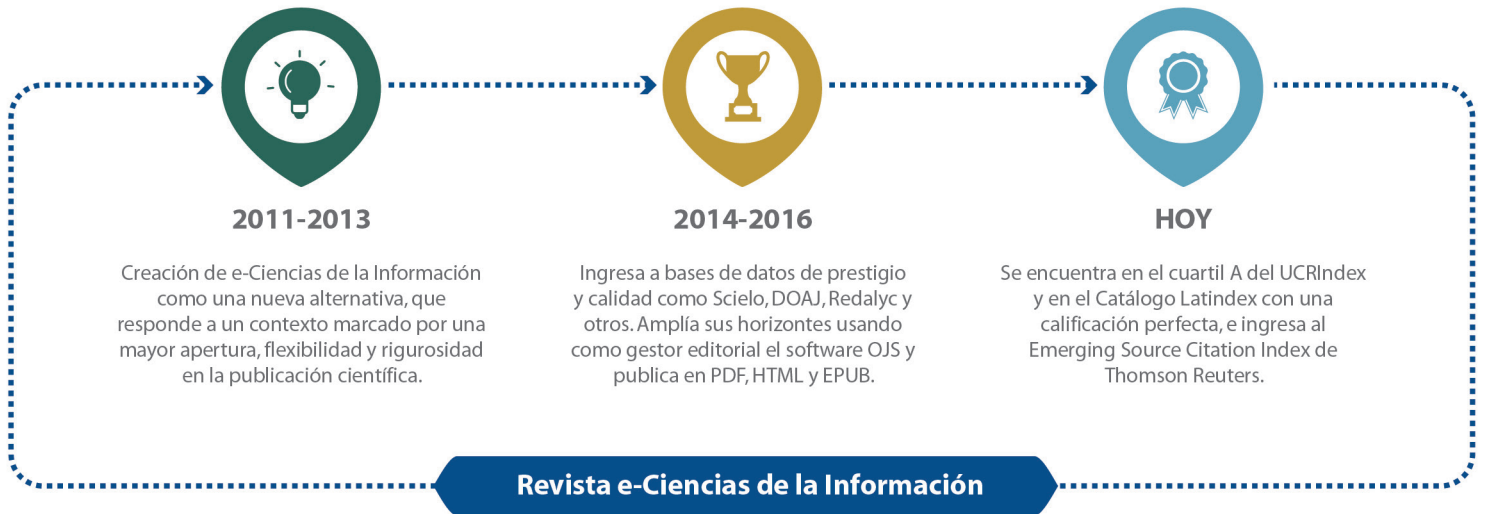

Where is it indexed e-Ciencias de la Información?



For more information, enter in our complete list of indexers

Do you want to publish your work?

Click [here](#)

Or write to us at the following address

revista.ebci@ucr.ac.cr